

5051 TRÄT FRÅN VÄRMOLOM  
UPPMÅTTNINGSDAG 1710  
VÄRMOLOM JUNI 1982  
H. SÄSE  
H. SÄSE VÄRMOLOM SVR  
1982 VÄRMOLOM  
0761/2000

085-2

Alla här presenterade båtar har skapats genom ett kreativt samarbete med uppdragsgivarna



**D-kanot Köping**

Löa 6,00

Böa 1,50

Sa 13,0

Dep 0,48

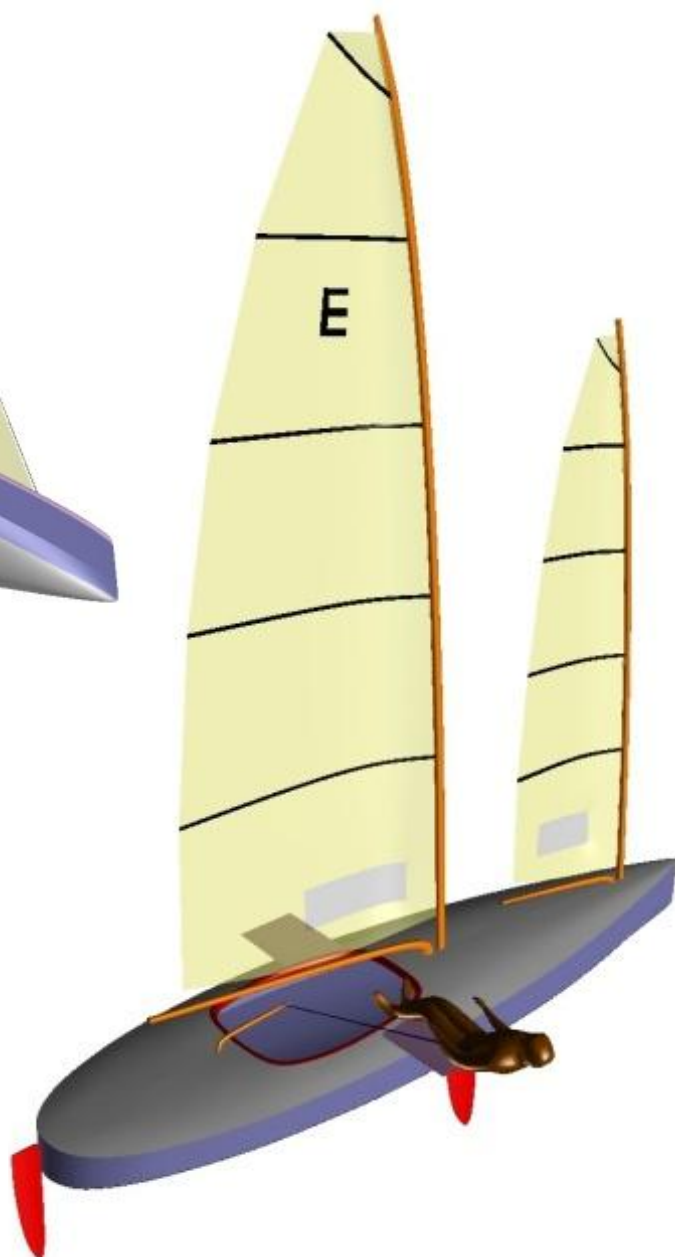

**E-kanot NC USA**

Löa 6,00

Böa 1,67

Sa 13,0

Dep 0,31

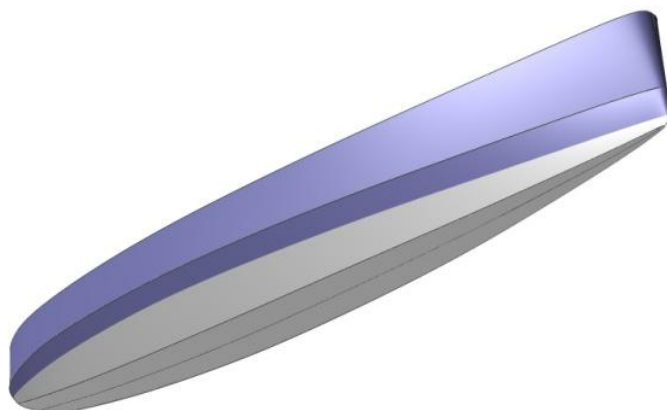

**Kapproddbåt Sicilien It**

Löa 6,00

Böa 1,67

Dep 0,54

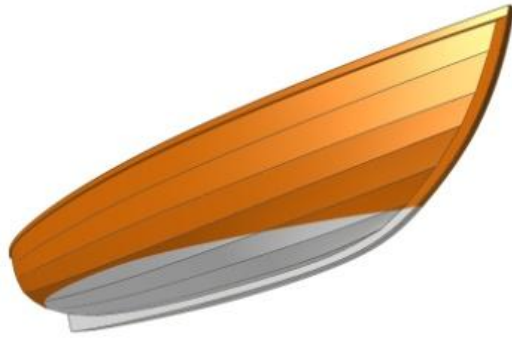

### Stensundseka Trosa

Löa 4,92

Lvl 4,12

Böa 1,51

Sa 11,0

Dep 0,33

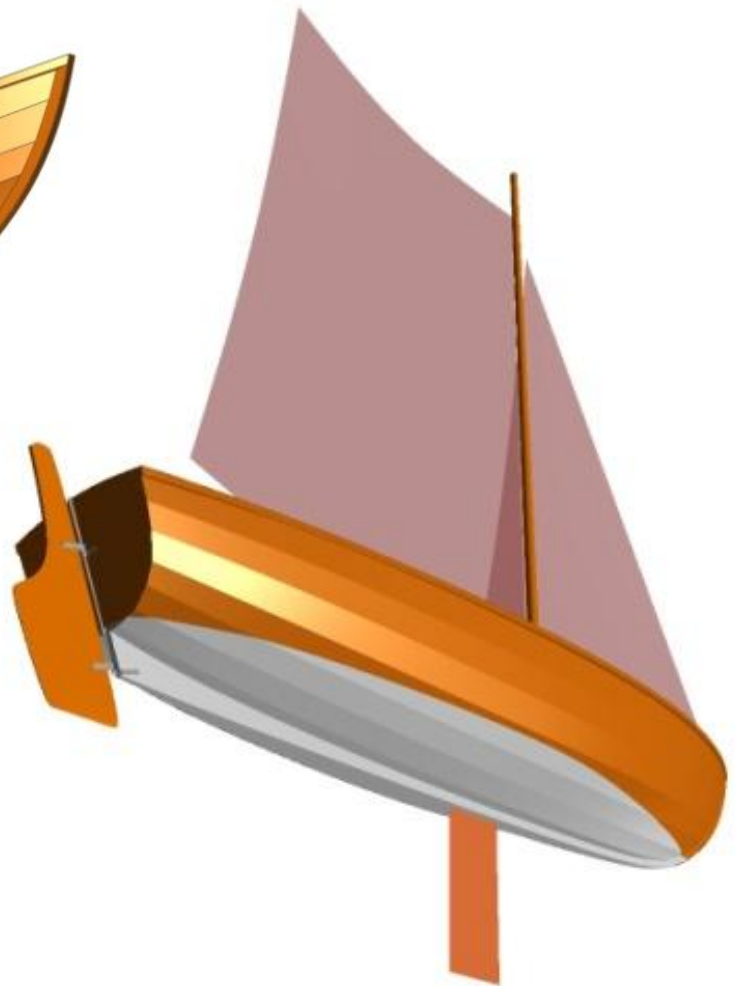

### Långbåt Vaxholm

Löa 6,78

Lvl 6,20

Böa 1,69

Sa 17,9

Dep 0,33



### Storbåt Roslagen

Löa 10,4

Lvl 8,3

Böa 3,2

Sa 80,3

Dep 5,2

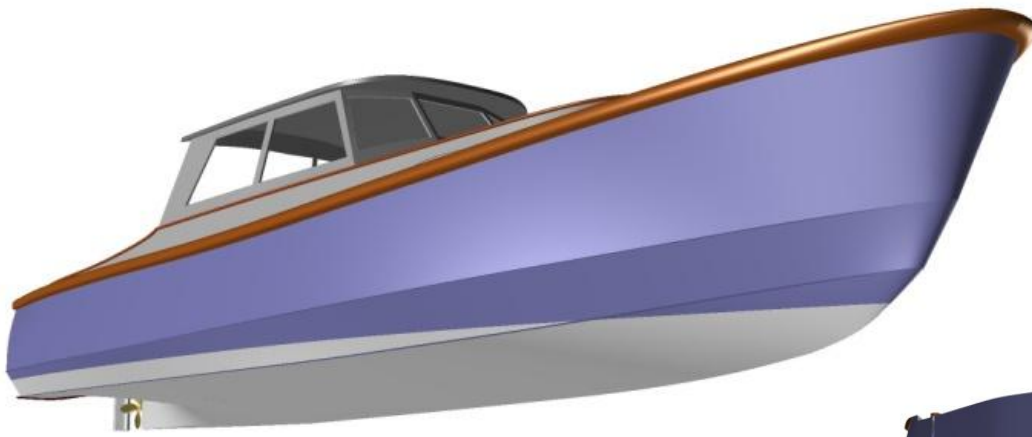

### Lobsterboat Maine USA

Löa 14,3

Lvl 13,2

Böa 4,2

Dep 14,7

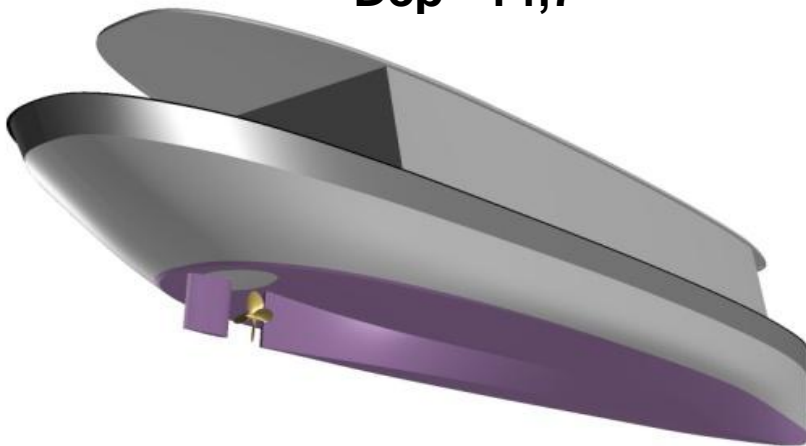
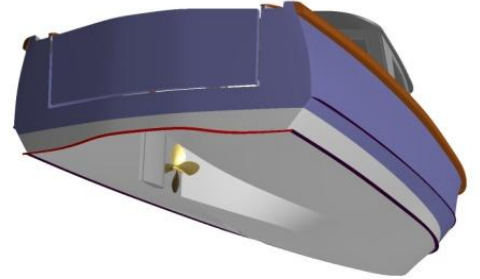

### Motorslup Vaxholm

Löa 14,0

Lvl 12,6

Böa 3,4

Dep 6,0



### Ångslup Österskär

Löa 8,4

Lvl 7,0

Böa 1,8

Dep 1,2

### Elmotorslup Gräddö

Löa 8,4

Lvl 7,0

Böa 1,8

Dep 1,2



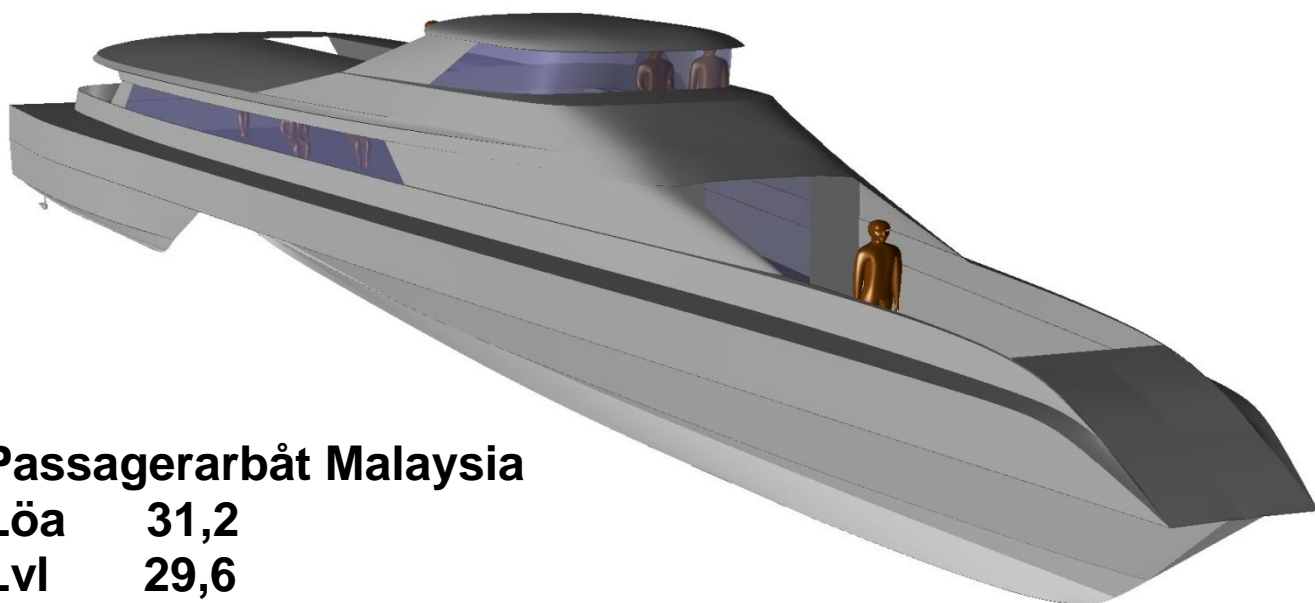

### Passagerarbåt Malaysia

Löa 31,2  
Lvl 29,6  
Böa 8,3  
Dep 32,0

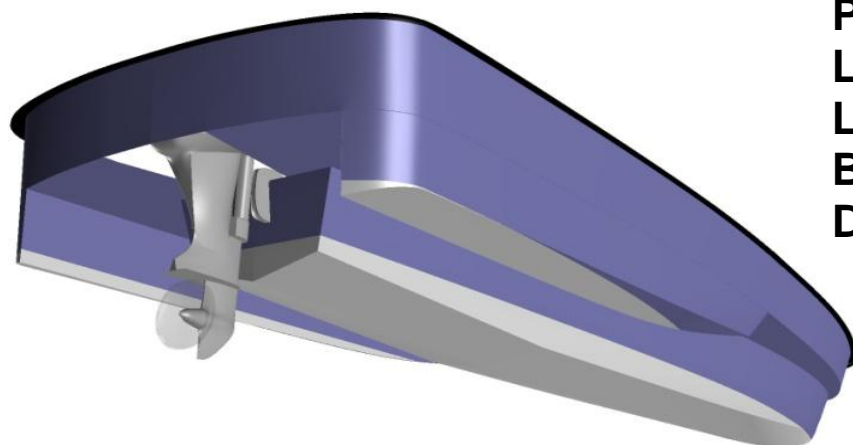

### Passbåt Rådmansö

Löa 5,7  
Lvl 5,1  
Böa 1,7  
Dep 0,3



### Långfärdsbåt Nynäs

Löa 11,0  
Lvl 10,4  
Böa 3,3  
Dep 3,0

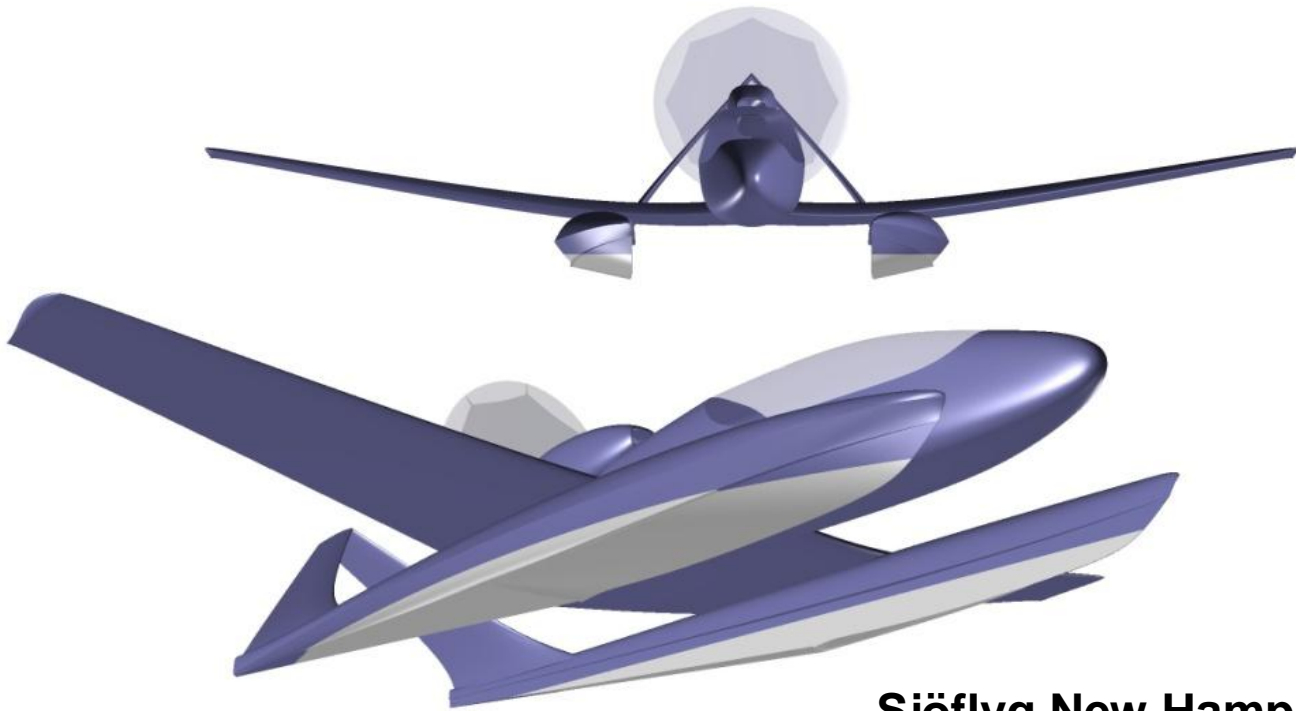

### **Sjöflyg New Hampshire**

**Löa 12,8**

**Lvl 11,8**

**Böa 12,7**

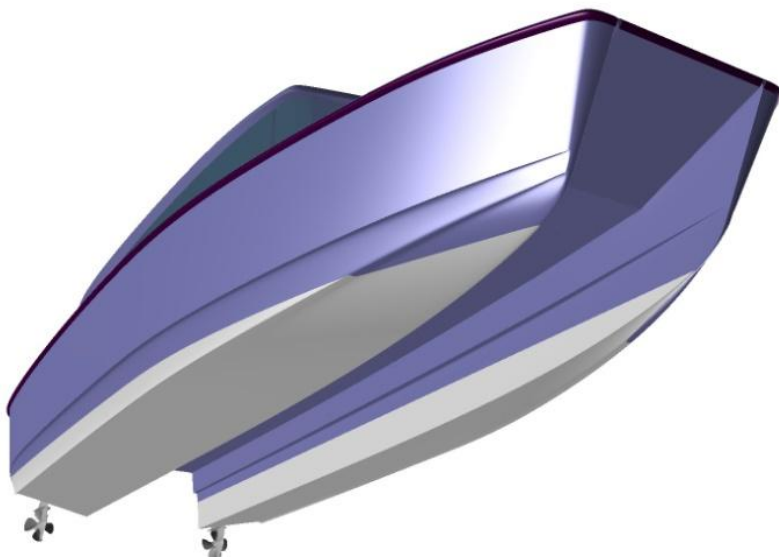

### **Taxibåt Ljusterö**

**Löa 8,8**

**Lvl 7,3**

**Böa 3,6**

**Dep 2,1**

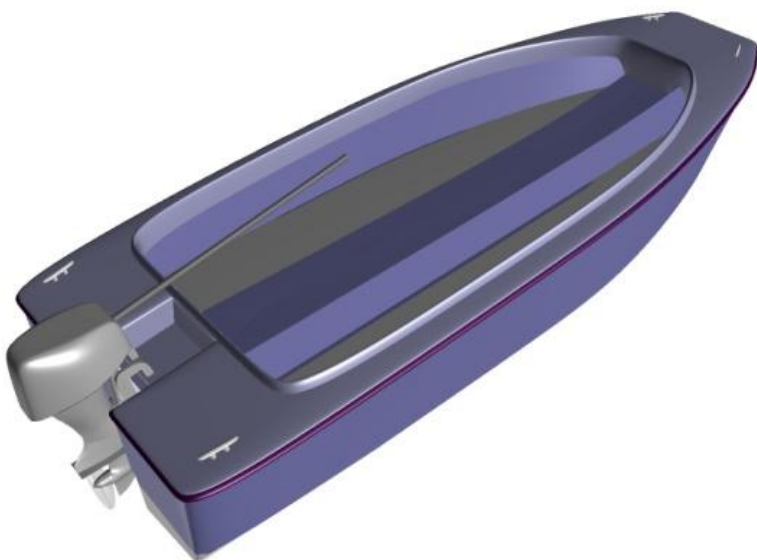

### **Passbåt Oskarshamn**

**Löa 4,1**

**Lvl 3,7**

**Böa 1,6**

**Dep 0,3**

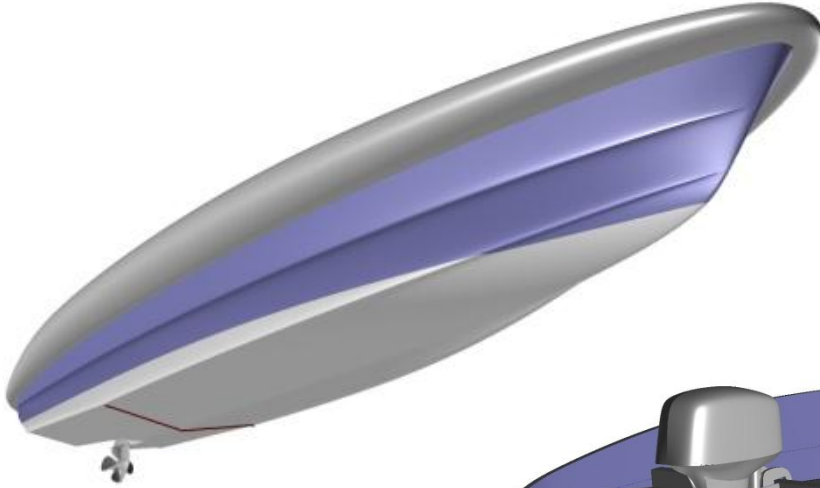

### Följebåt Seglarskola Fi

Löa 5,6

Lvl 4,9

Böa 1,9

Dep 0,4

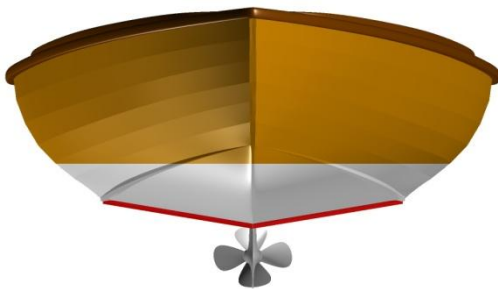
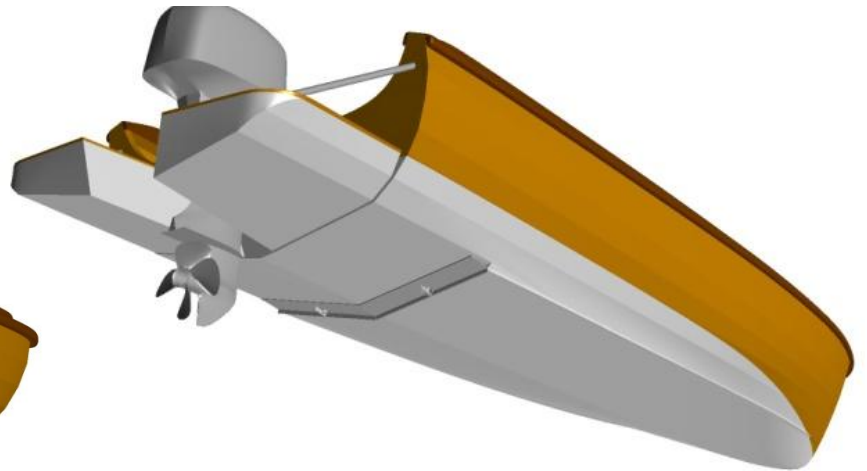
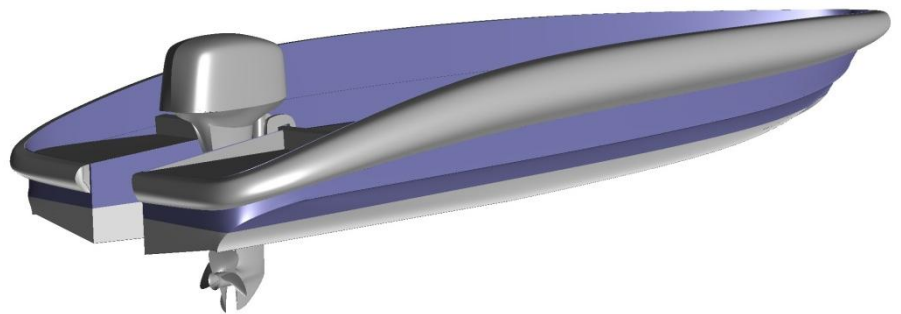

### Passbåt Holmön

Löa 7,4

Lvl 6,9

Böa 2,0

Dep 1,1

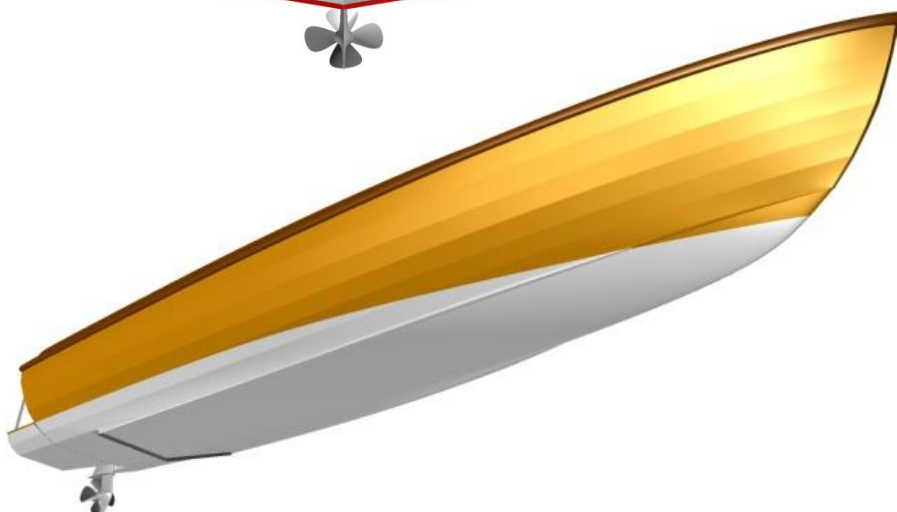

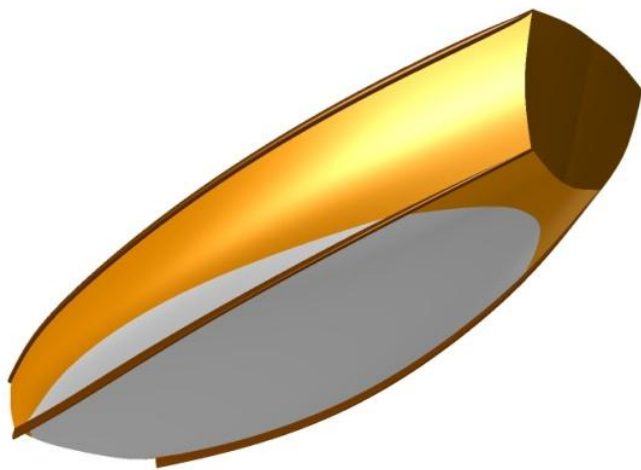

### **Släpjolle Tunarp**

**Löa 2,70**

**Lvl 2,40**

**Böa 1,10**

**Dep 0,12**

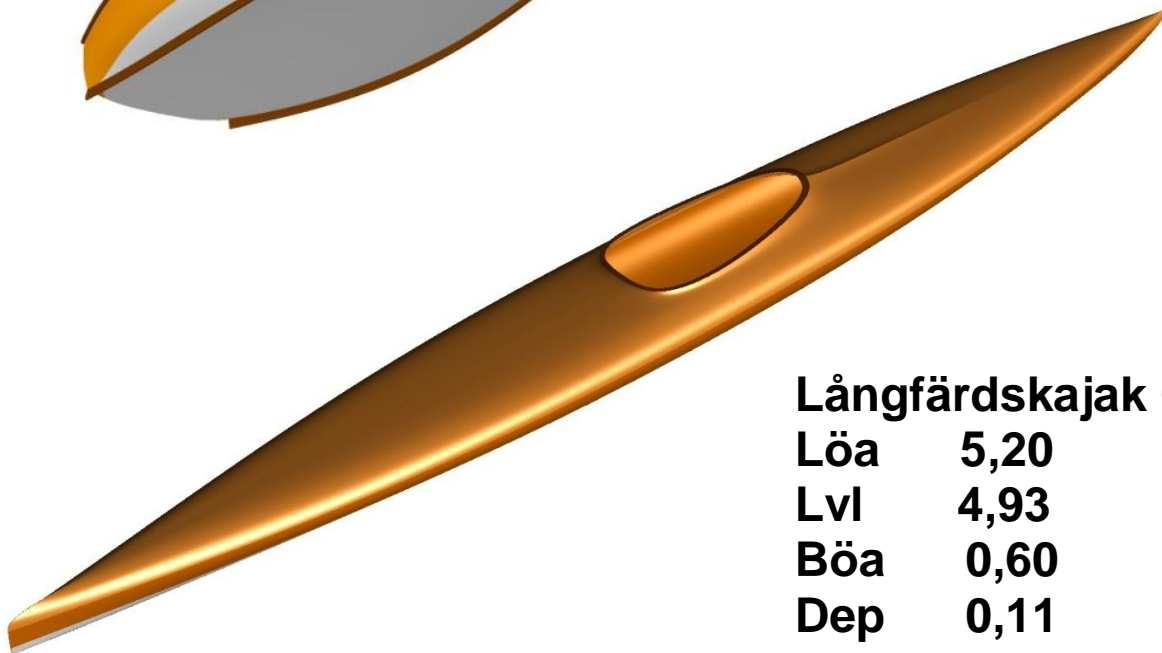

### **Långfärdsajak Gillöga**

**Löa 5,20**

**Lvl 4,93**

**Böa 0,60**

**Dep 0,11**

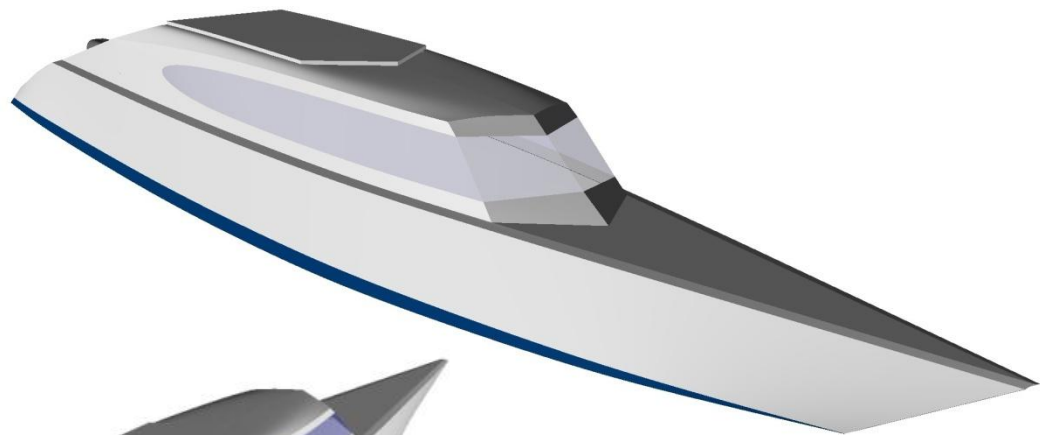

### **Sharpie Clipper**

**Löa 11,0**

**Lvl 10,0**

**Böa 1,8**

**Dep 1,5**

